

SAPPHIRE WALL SYSTEM

Transaction Window Installation

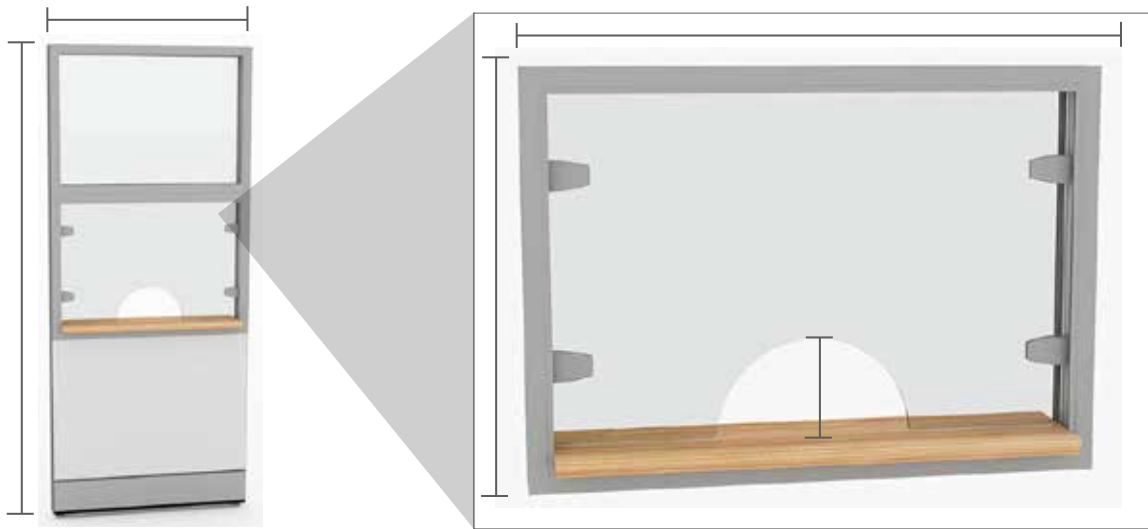

888-993-3757
skutchi.com

Open Window Installation

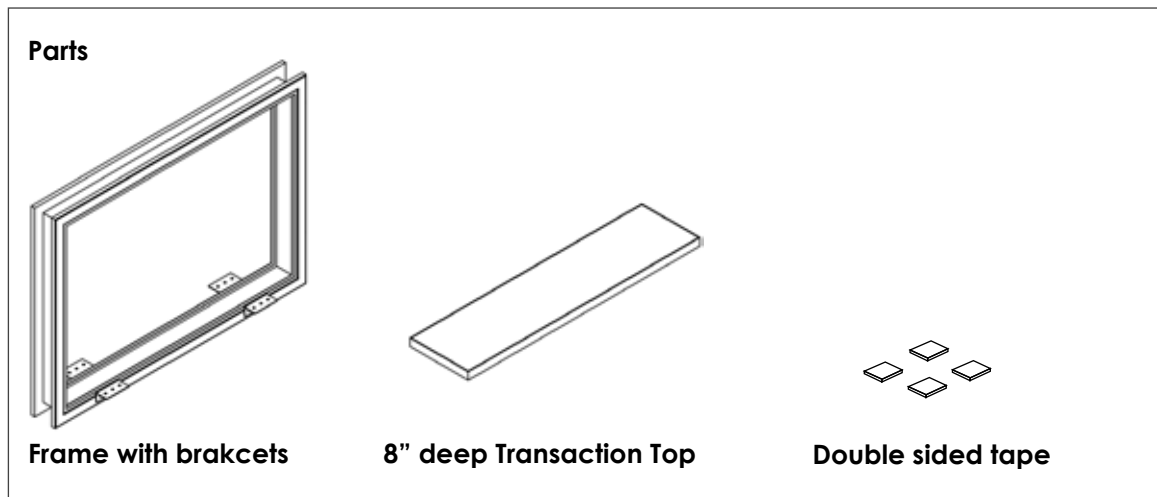

1 Attach tile frame to panel

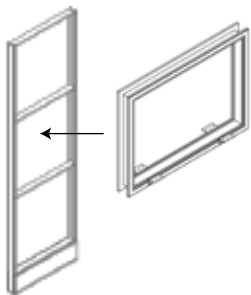

2 Place transaction top on bottom of tile frame using double sided tape. Make sure top is centered.

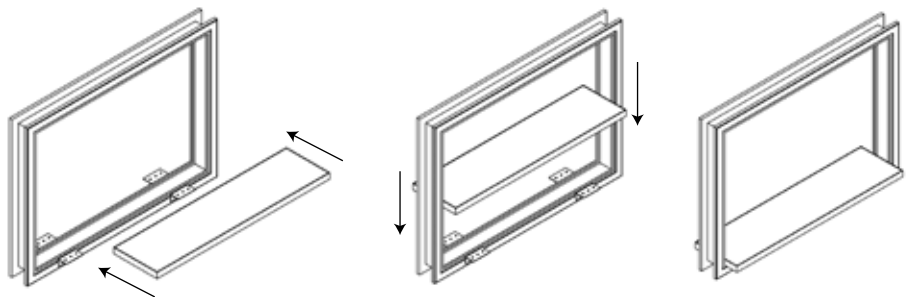

Sliding Window Install



Parts



Frame with brackets

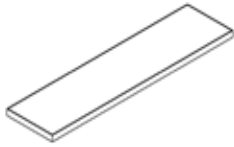

8" deep Transaction Top

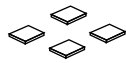

Double sided tape



Clear Acrylic Sliding Doors



Top Guide



fibre inserted bottom track



Screws

1 Attach tile frame to panel

2 Place transaction top on bottom of tile frame using double sided tape. Make sure top is centered.

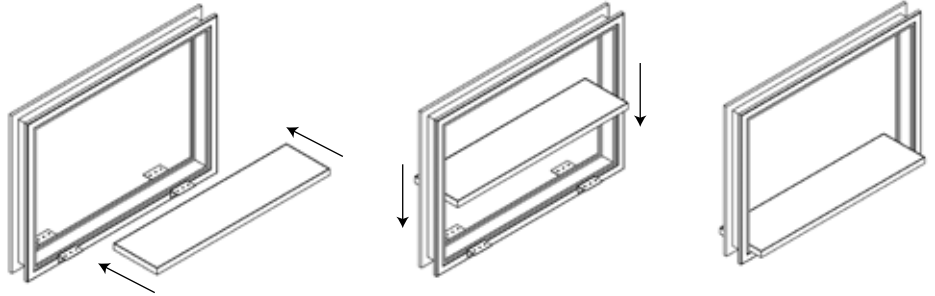
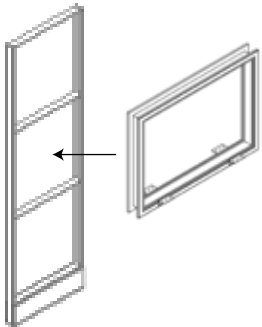

Attaching Top Guide and Bottom Track

Ex.1

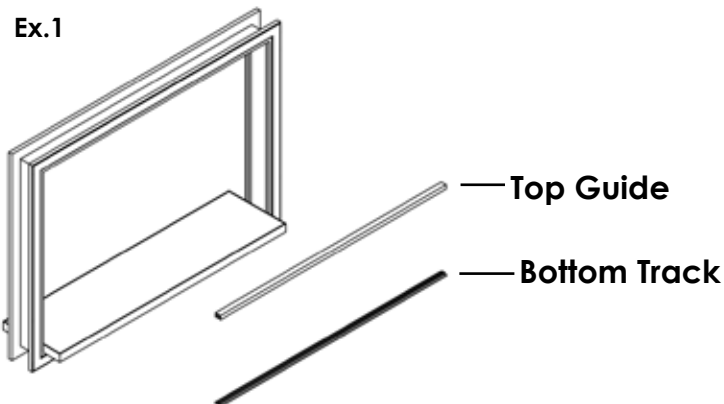

Ex.2

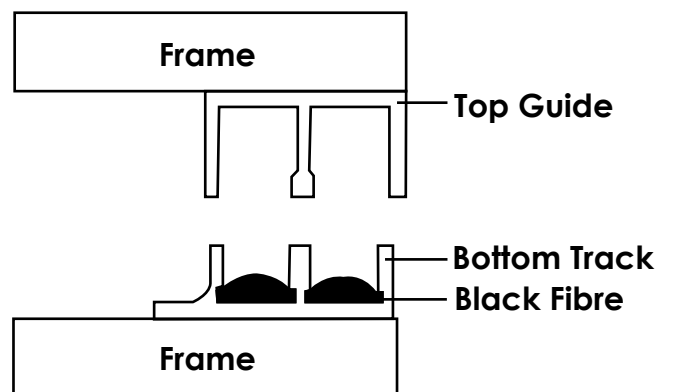

- 3** Using the small screws, first attach the top guide to tile frame by screwing up into the frame. Next **loosely** attach the bottom track (track with black fibre) to the transaction top by screwing down into the transaction top. Leave this loose until acrylic doors are inserted. Line tracks where the acrylic doors will be flushed with the public side of the window.

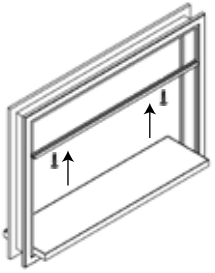

***Be sure to attach the top guide first.**

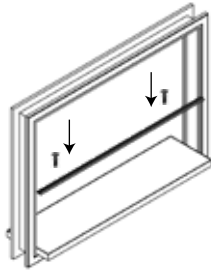

***Leave bottom track loose so acrylic doors can be inserted.**



- 4** Install clear acrylic sliding screens by tilting then inserting into tracks. Place top end into top guide, then bottom on respected sides.

*Inserting first screen

*Inserting second screen

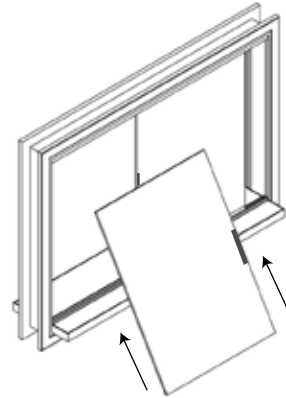
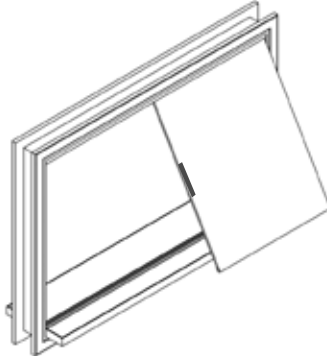
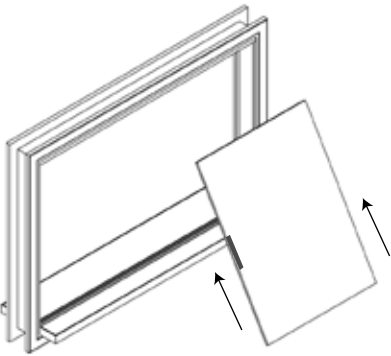

- 5** Be sure to tighten down bottom track once screens are inserted.

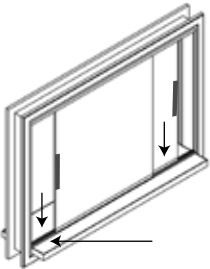

*Finished Window

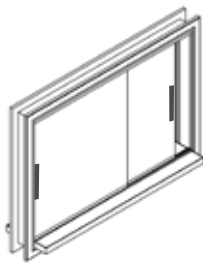
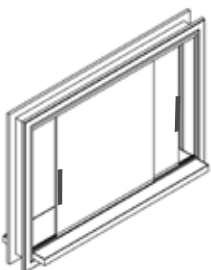

Acrylic Window Install

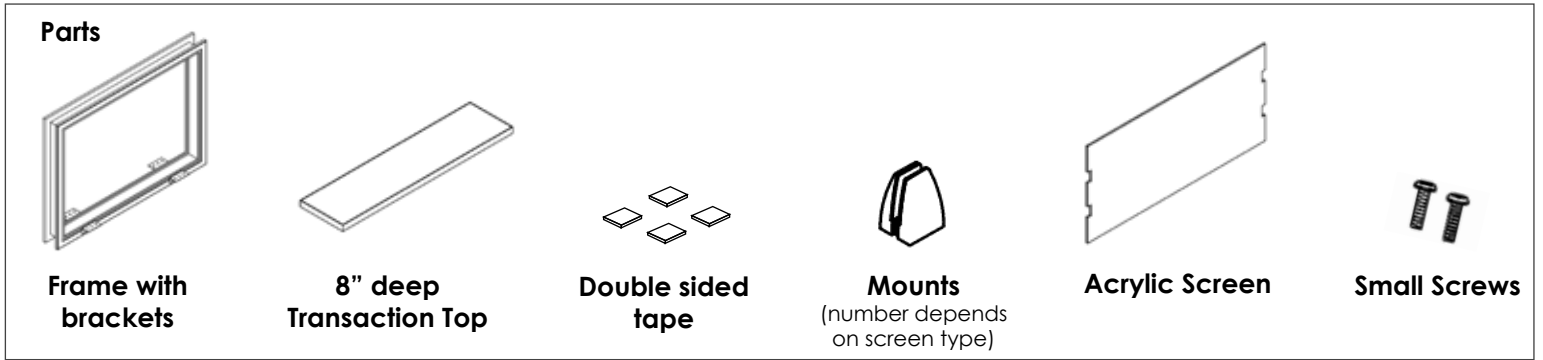

1 Attach tile frame to panel

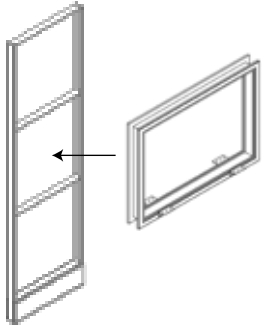

2 Place transaction top on bottom of glass tile using double sided tape. Make sure top is centered.

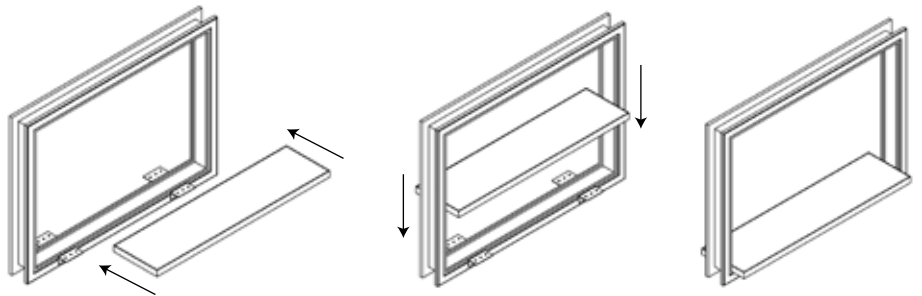

3 Using acrylic as a guide, center mounts on frame and attach one side of mount with small screws. Place plastic pieces on inner part of the mounts.

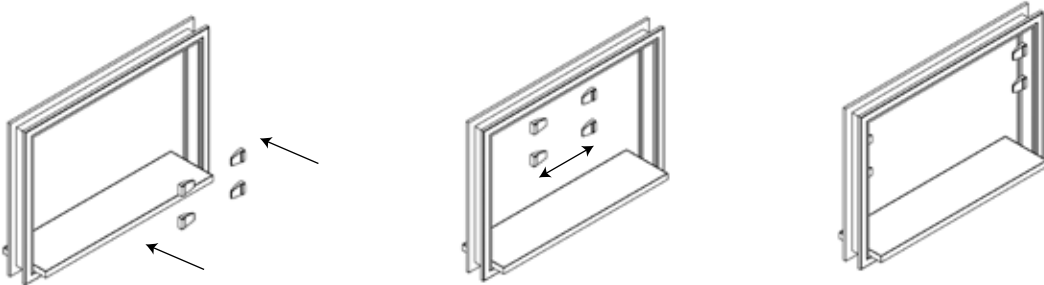

4 Place the acrylic screen in the tile frame lining up notches with mounts. Place plastic washers in other part of the mounts not yet attached. Then connect to the other part of the mount already attached to the frame. Secure with hex bolt.

