

SAP^{slim} Cubicle System

Installation Guide



888-993-3757
skutchi.com



1/4 Driver

Identifying Parts

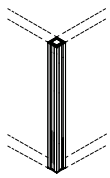

2 Way

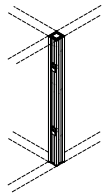

3 Way

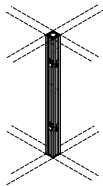

4 Way

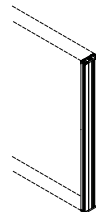

End Trim

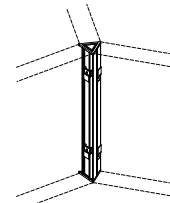

**120 Degree
3 Way**

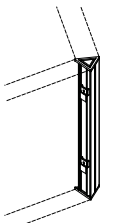

**120 Degree
2 Way**

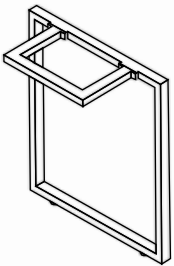

Box Leg

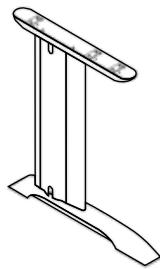

C Leg

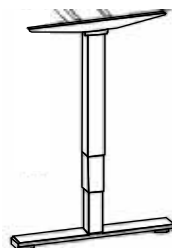

**Square Column
Sit-Stand Base**

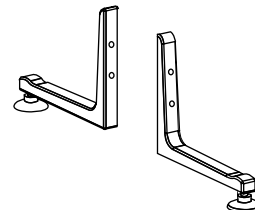

Feet without Casters

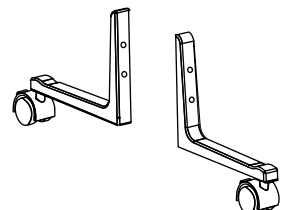

Feet with Casters



Right Cantilver



Left Cantilver

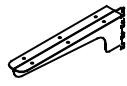

Double Cantilver

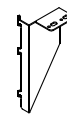

**Corner Worksurface
Support**



**Acrylic Screen
Mount**

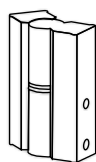

Hinge



Panel Hooks

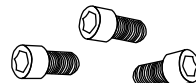

Hex Screws

Connecting Panels

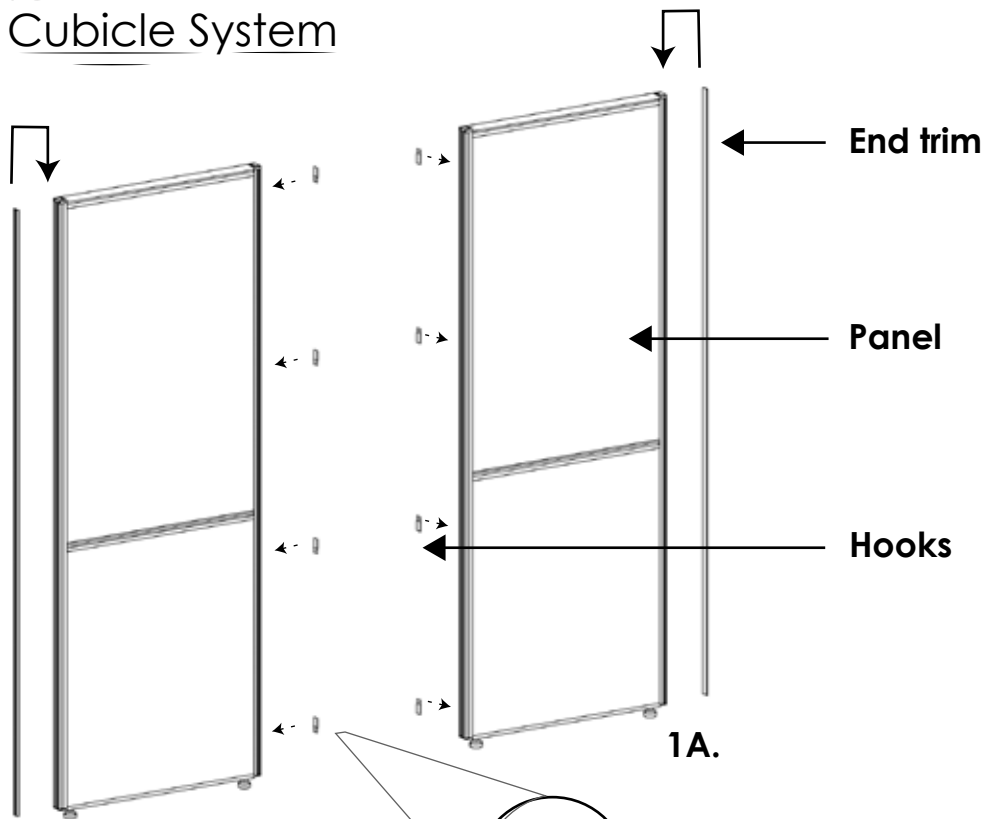

1A.

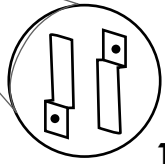

1C.

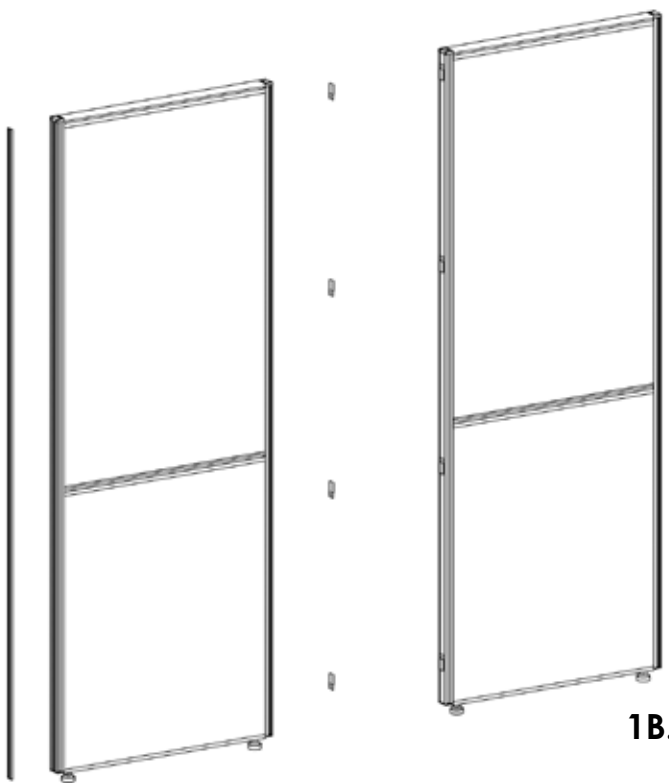

1B.

Ex. of hook on panel



1C-2.

End trim Install:

To insert end trim, lift up top cap (see below) then slide end trim into slot with ridges facing outward.

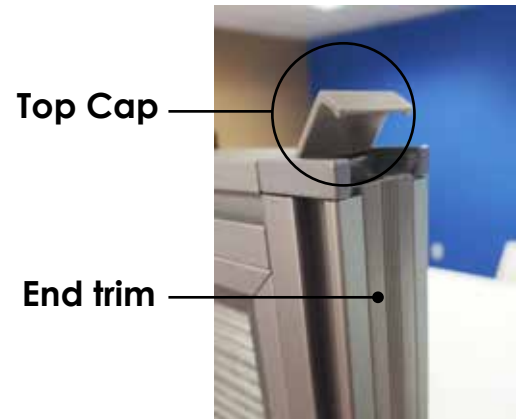

1D.

*No tools are required to lock SAPslim panels together.

1. Install hooks onto panels first. Panels connect by one hook angled north and the other hook angled south.
2. Once hooks are in place, line up panels and connect them by the hooks by sliding one set of hooks into the other and push down on panels to lock into place.
3. Install end trim (figure 1D.)

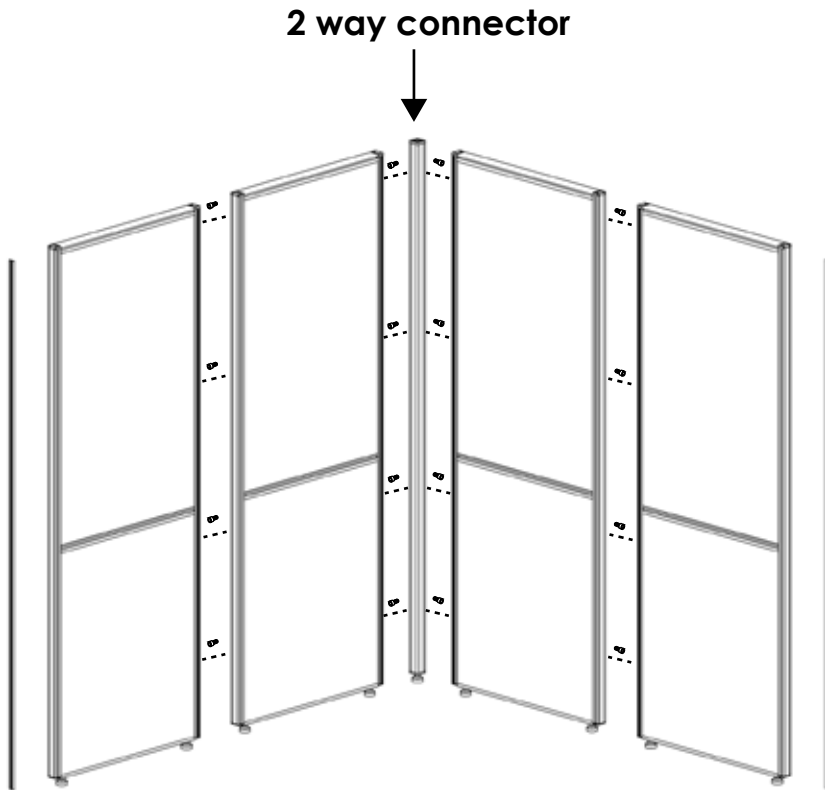

Connect the panels to the connector first and then attach second set of panels.

These attach the same way as attaching 2 panels together (reference figure 1A.).

End trim:
Flip up the top cap and slide plastic end trim in place.
Snap top cap back down when finished. (see figure 1D.)

Connecting SAPslim to the Sapphire Cubicle System

1. SAPslim panel and connector attach the same way 2 panels connect (reference figure 1A.).

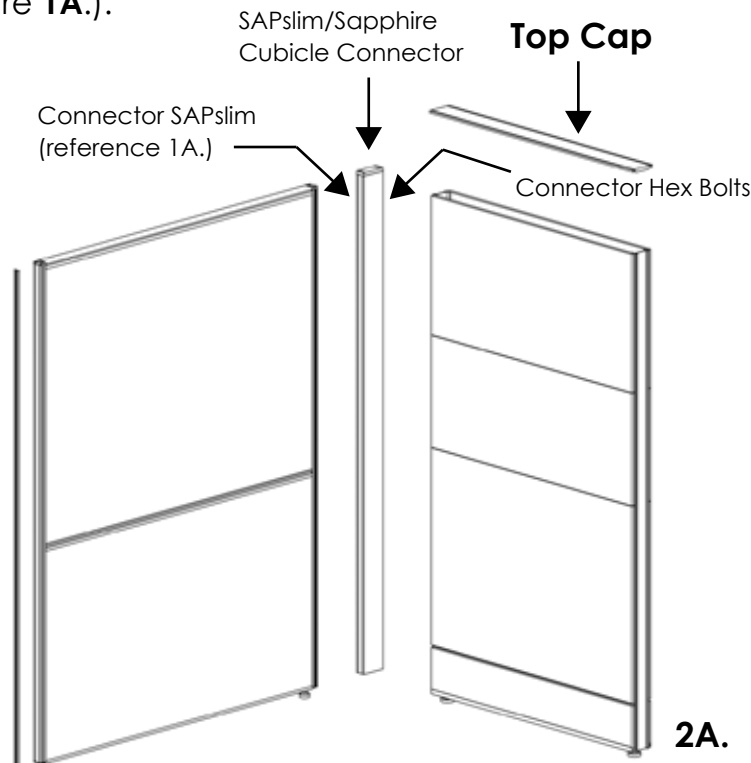

2. Sapphire Cubicle panel attaches to connector by using a washer and hex bolt. (figure 2B.).

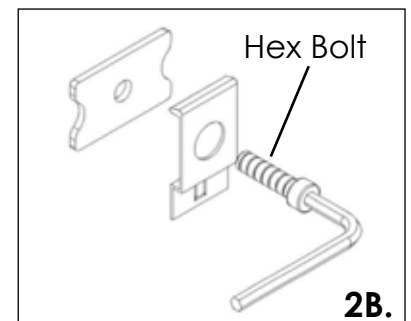

View Installation Videos Here:

Connectors & End Trim

<https://www.youtube.com/watch?v=s5UeE-GUwKro>

Worksurface & Levelers

<https://www.youtube.com/watch?v=9xRmg-tRoBks>

Hinge Assembly

3A.

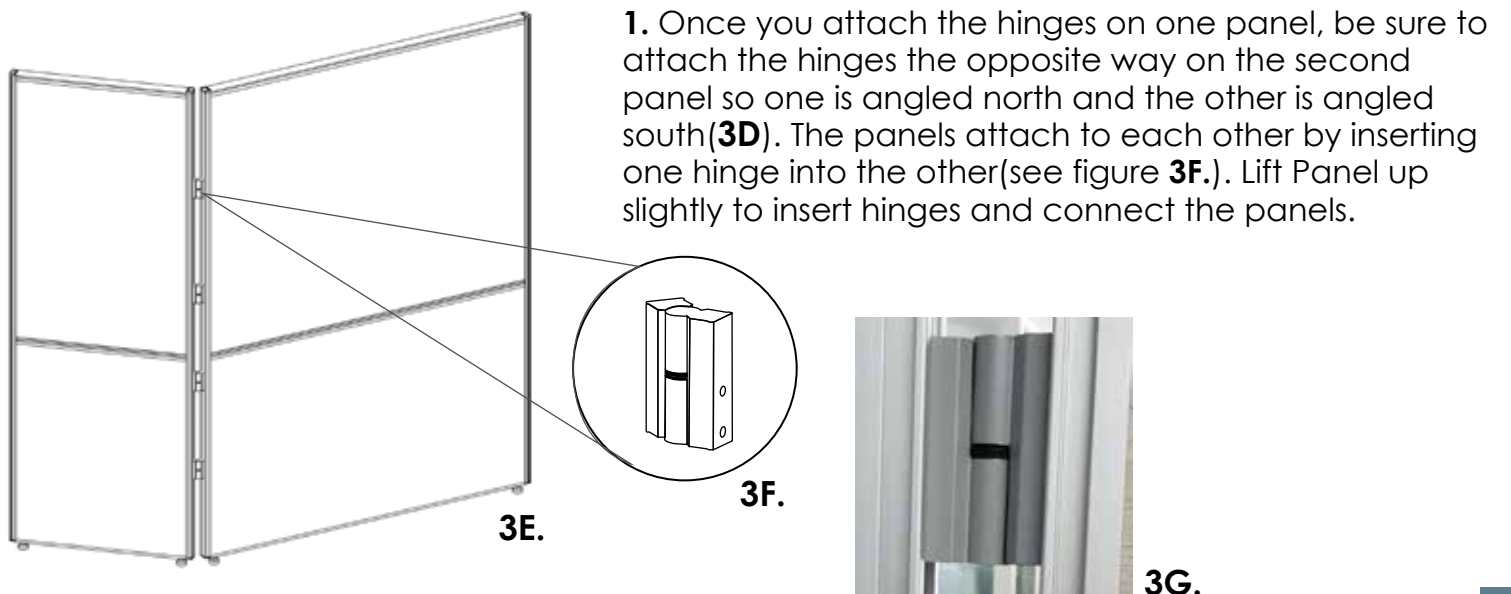
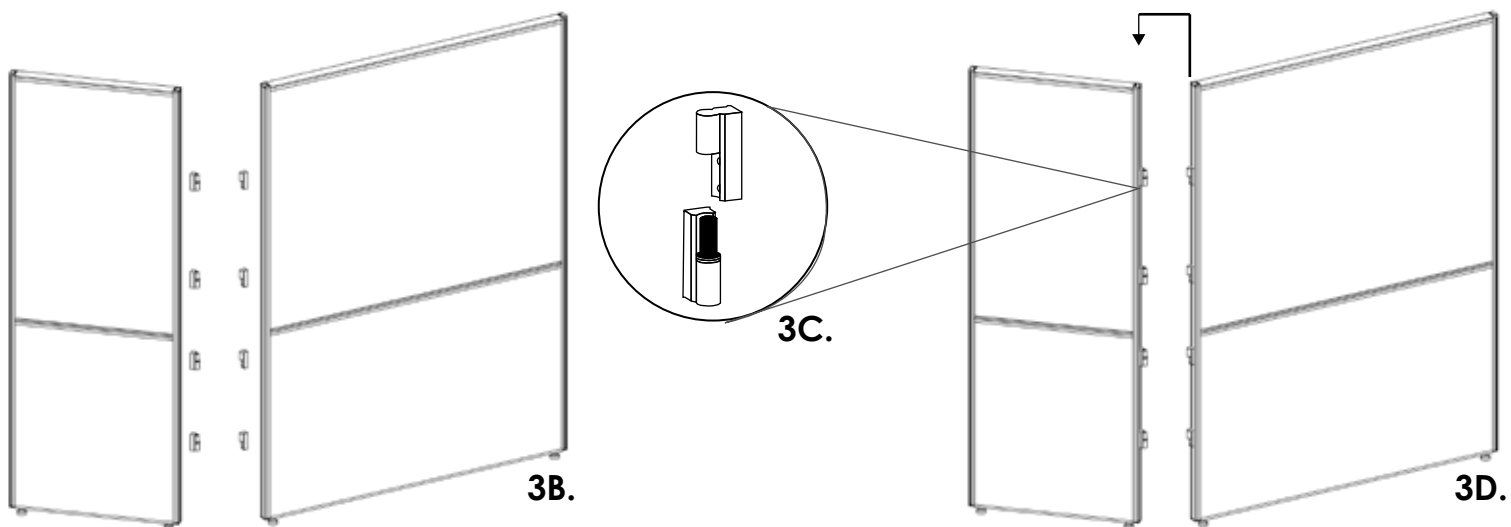
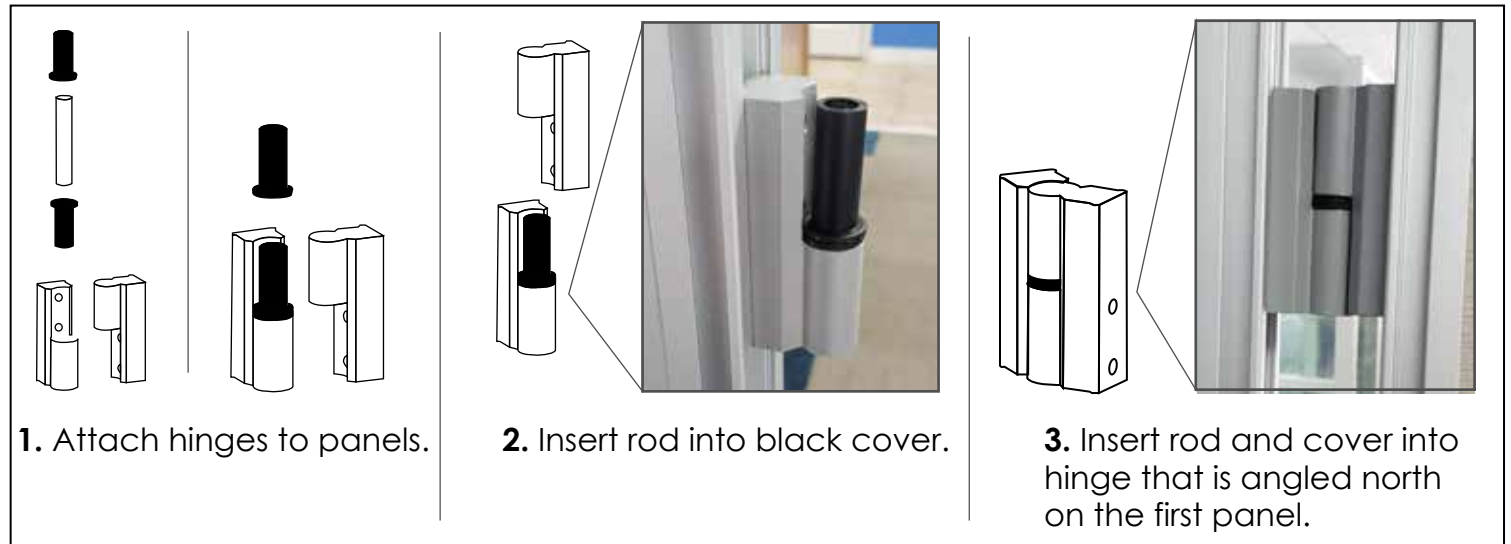

Installing Feet Support

*If using feet on panels attach them before attaching the panels together.

Panel with feet

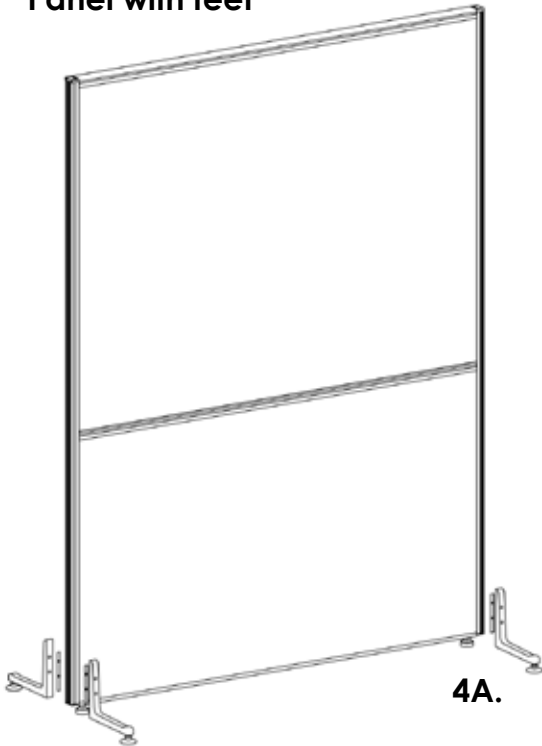

Panel with feet (castors)

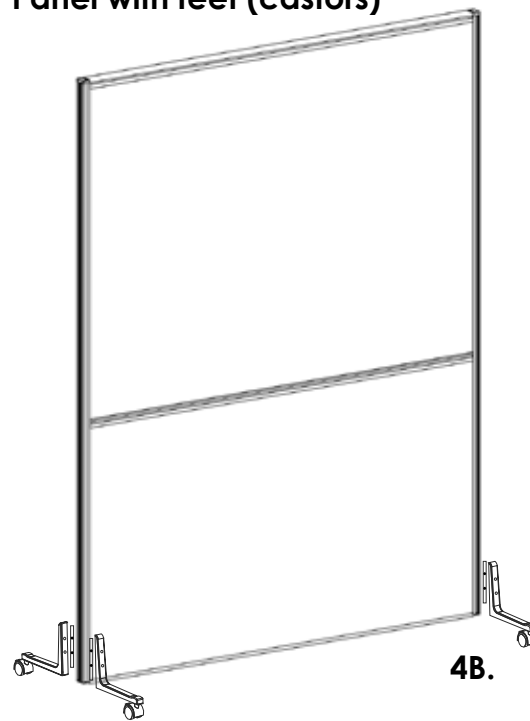

***Note:** If attaching 2 or more panels together use only one foot between two panels. (see below).



***When using hinges on connecting panels a wheel can be added to one of the panels in place of the foot so the panel moves more freely. (see below).**

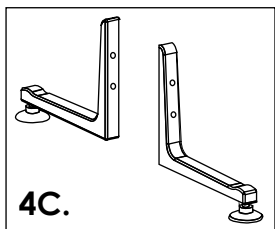
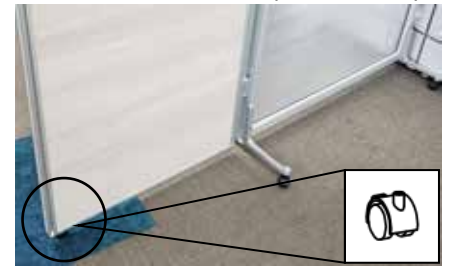

Feet without Casters

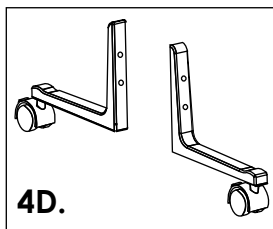

Feet with Casters

1. Feet come in two pieces. Attach each piece to each side of the panel. Place plate in between foot and panel before screwing in the foot. (See 4A.)

2. If adding on a wheel to the hinged panels, simply screw in the wheel from the bottom of the panel.

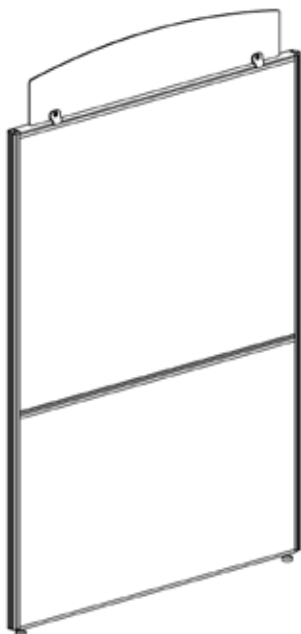

Installing panel extender

