

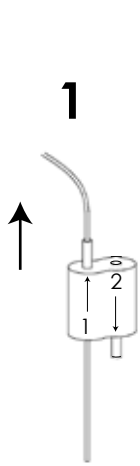

## Hanging Acoustical Panel Installation Guide

## Installing Hanging Hardware

\*Ceiling mount is not provided



Insert cable into looping gripper

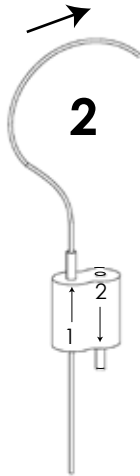

Pass cable through or around anchor point

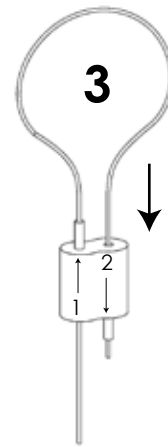

Insert cable back into looping gripper. Cable must exit looper gripper by a minimum of 1 in.

## Identifying Parts

\*Wire can be cut to size but must be cut at an angle

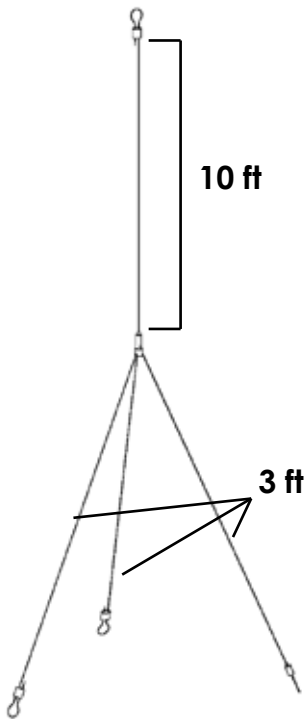

Available in 3 or 4 chains



3 Chain



4 Chain

Brass Adjuster (Griplock)



D-ring with chain and looping gripper

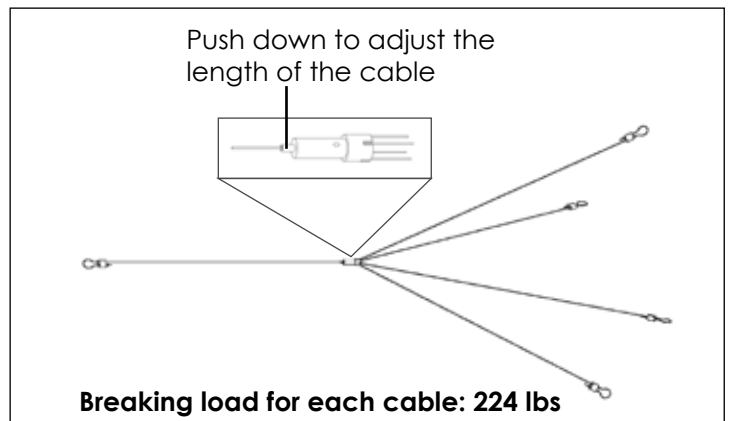

\*D-ring quantity varies based on the size of the panels.

### Step 1:

Locate markings on circle panel.

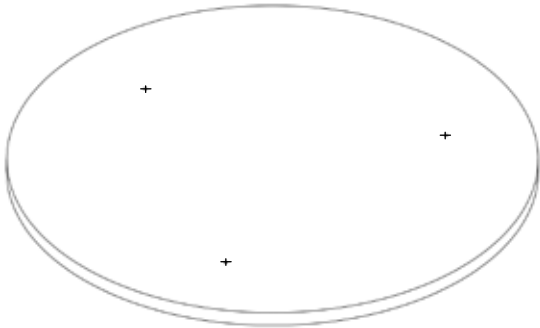

### Step 2:

Place D-rings on panel in marked areas and attach with screws provided.

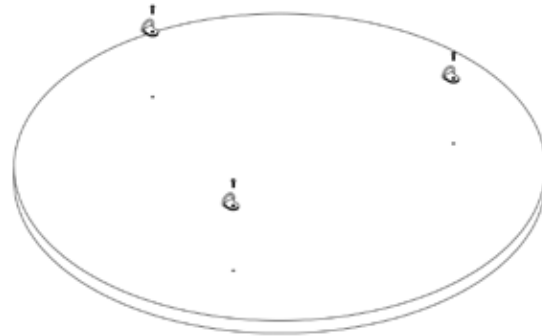

D-ring close-up

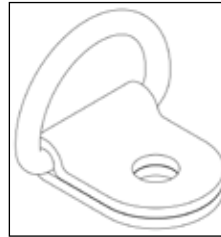

### Step 3:

Secure D-rings in place.

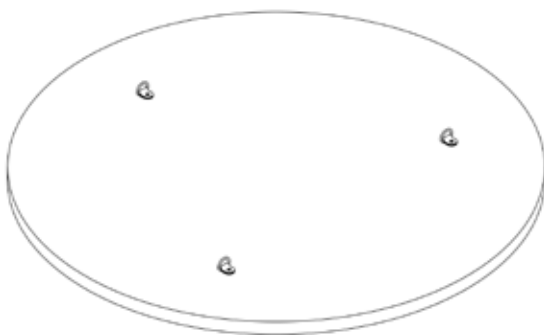

### Step 4:

Attach chains and hang in desired location.

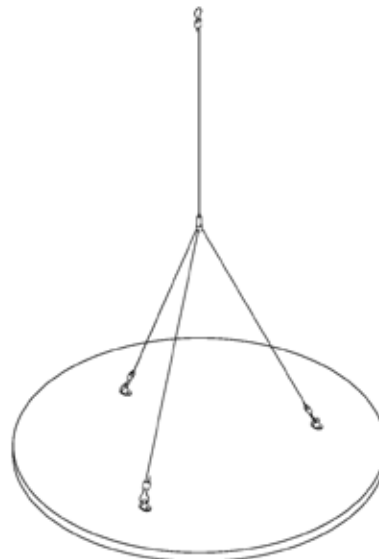

\*D-ring quantity varies based on the size of the panels.

### Step 1:

Use provided template to make markings for D-Rings.

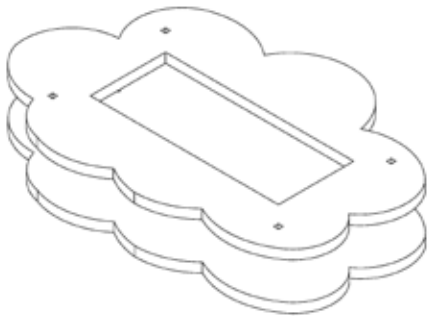

### Step 2:

Locate markings on cloud panel.

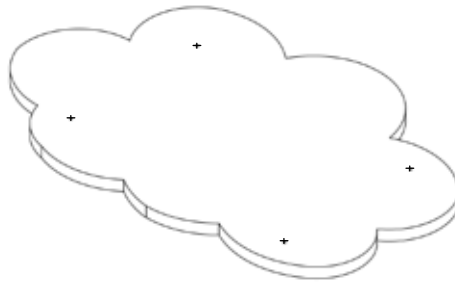

### Step 3:

Place D-rings on panel in marked areas and attach with screws provided.



### Step 4:

Secure D-rings in place.

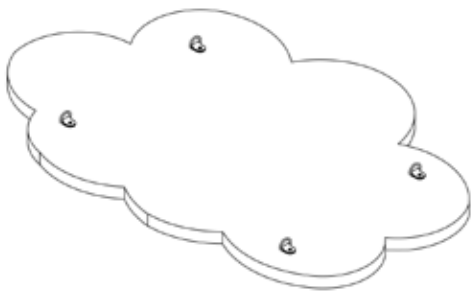

### Step 5:

Attach chains and hang in desired location.

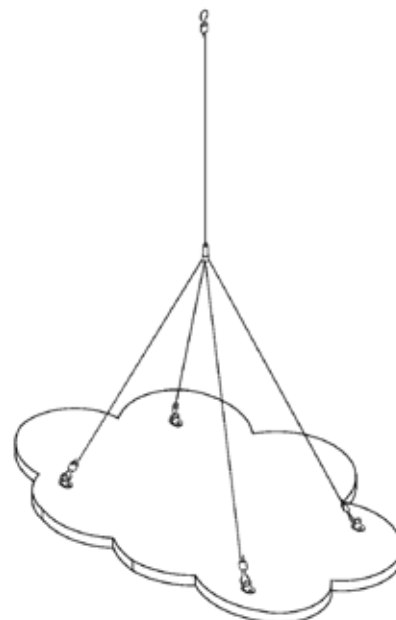

# HANGING RECTANGLE PANELS

\*D-ring quantity varies based on the size of the panels.

## Step 1:

Locate markings on rectangle panel.

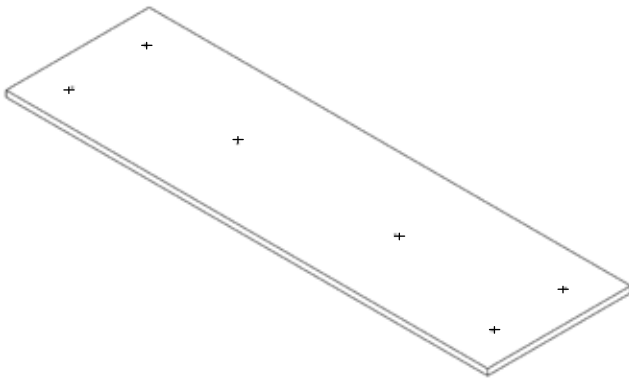

## Step 2:

Place D-rings on panel in marked areas and attach with screws provided.

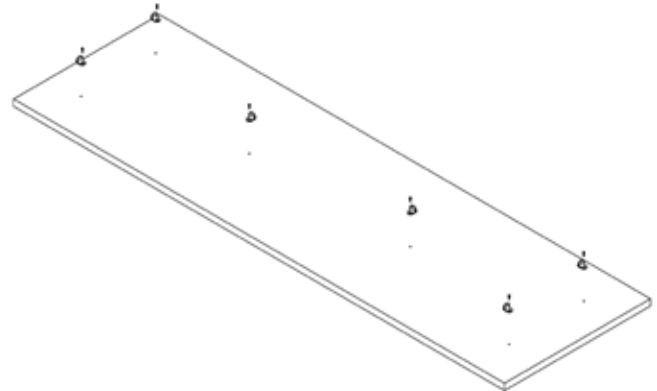

## Step 3:

Secure D-rings in place.

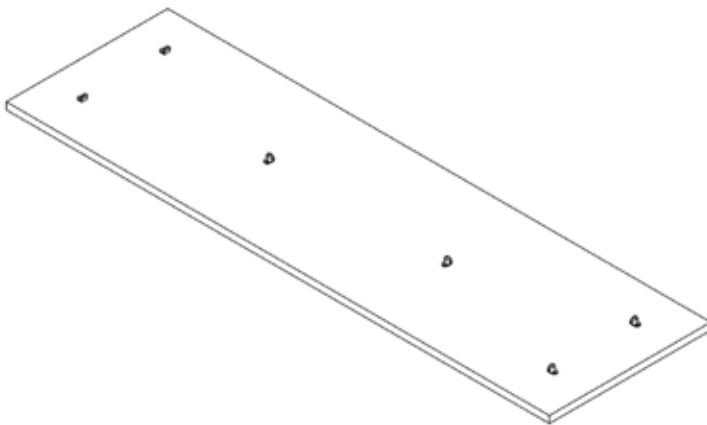

## Step 4:

Attach chains and hang in desired location. (**Chains are not provided by SKUTCHI.**)

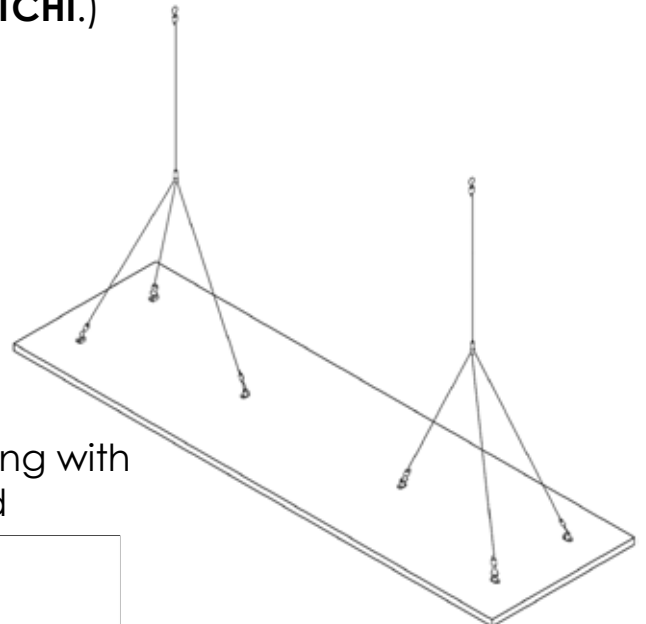

Close-up of D-ring with chain attached

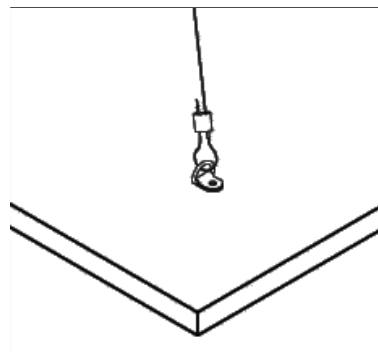

# HANGING RECTANGLE PANELS

## Step 1:

Panel will come with U-channel already attached.



## Step 2:

Attach chains and hang in desired location. (**Chains are not provided by SKUTCHI.**)

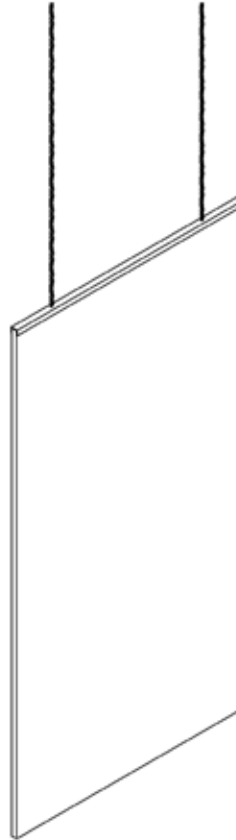

Close-up of U-channel

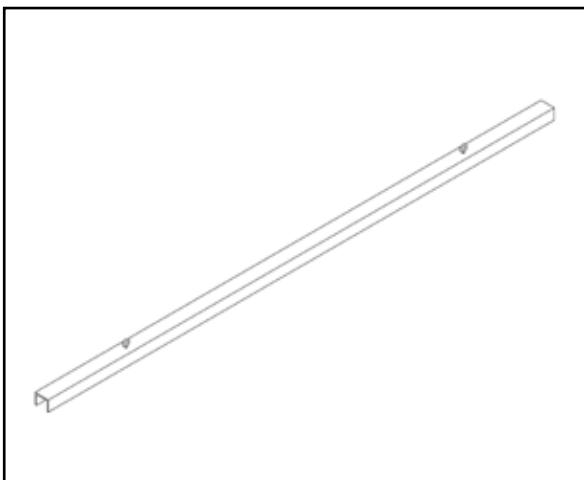

Close-up of U-channel with chain attached

