

EMERALD CUBICLE COLLECTION

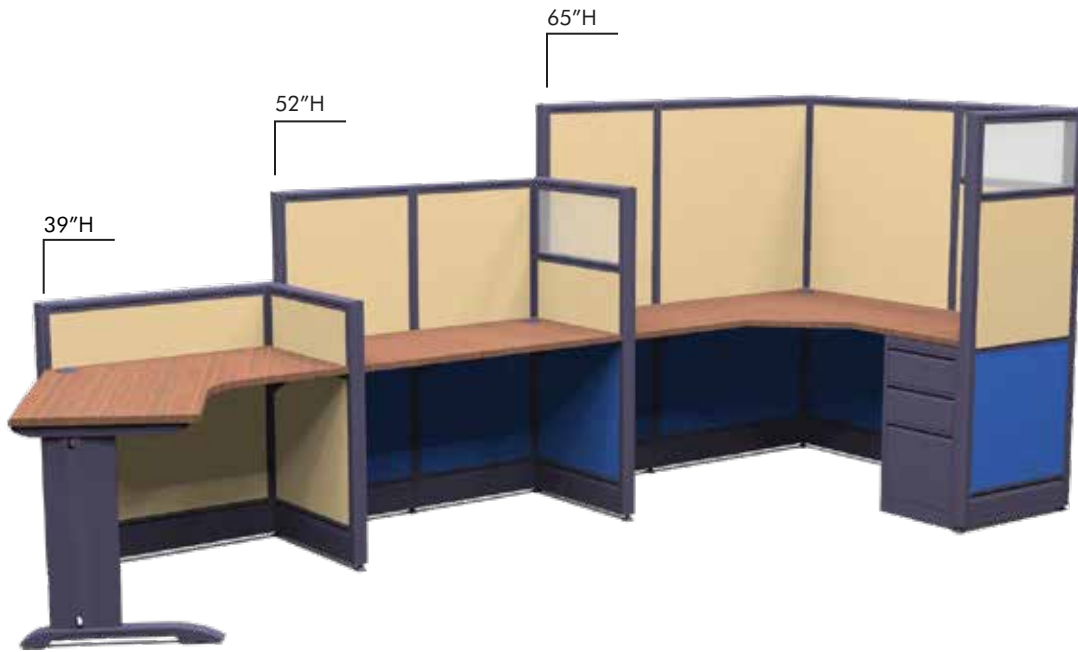

888-993-3757
SKUTCHI.COM



EMERALD CUBICLE COLLECTION

The Emerald Cubicle Collection by SKUTCHI Designs Inc. is one-stop solution to your workplace cubicle and workstation furniture needs. The Emerald Cubicle Collection series utilizes immensely strong, powder-coated aluminum frames and 2 1/2" thick, tackable fabric panels to create individual or interconnected workstation cubicles at panel heights of 39", 52", or 65".

With hundreds of custom configurations available, the Emerald Cubicle Collection offers a choice of 14 different fabric colors, tempered glass-topped panels with 8 different film appliques, and worksurfaces featuring 8 different laminate textures.

SKUTCHI Designs Inc. excels in creating cubicle systems of endless color, glass, and worksurface combinations which can accommodate a single person... or hundreds. The Emerald Cubicle Collection uses straight, 2-way, 3-way, or 4-way connectors to create cubicles which are L-shaped, U-shaped, enclosed, or 120-degree cubicle arrangements of truly unique shapes and varying sizes.

The Emerald Cubicle Collection offers more than just walls and panels. Choose from a wide-ranging inventory of ergonomically designed furniture and accessories such as workstation desktops, sit-to-stand desks, locking file storage cabinets, scalable shelving, locking overhead storage containers, dry-erase boards, padded-top sitting and storage benches, paper rack organizers, bookshelves, and accessory rails.

If cubicle spaces require electrical outlets or data network cable connectors, the Emerald Cubicle Collection features built-in "raceway" conduits to provide both hidden and seamless electric and data integration.

In short, the Emerald Cubicle Collection offers a mid-line, "all-in-one" solution for your workspace. Since its form and function is modular by design, it can be expanded out, combined with, moved around, replaced, and have its furniture exchanged between cubicles if ever needed.

All materials used with the Emerald Cubicle Collection meet or exceed the safety and durability specifications set forth by the American National Standards Institute and the Business and Institutional Furniture Manufacturers Association.

- 2 1/2" Thick Panel walls
- Optional Panel Finishes: Tackable fabric
- We offer glass tops (12" and 24" heights) to give a feel of open space and natural light
- Single hinged 6"H cable channel for wire management on the bottom of ea. panel.
- Panel heights: 39", 52", and 65"
- Custom and quick-ship options available
- Fabric ISO 9001
- Electric: UL Listed
- ANSI/BIFMA

Height Chart

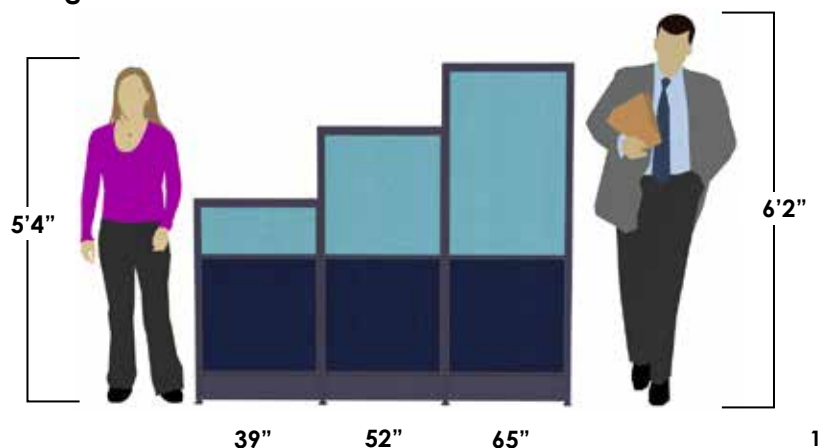

39" H Solid Panels

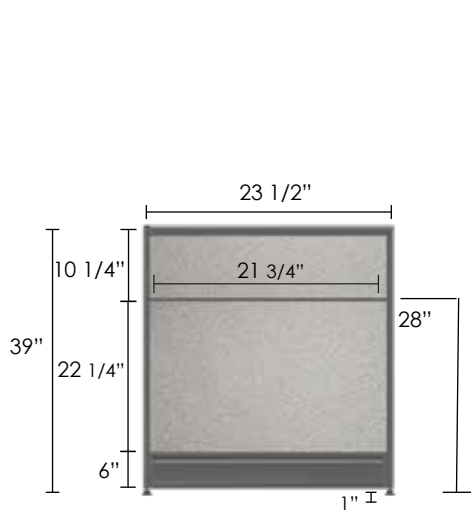

52" H Solid Panels

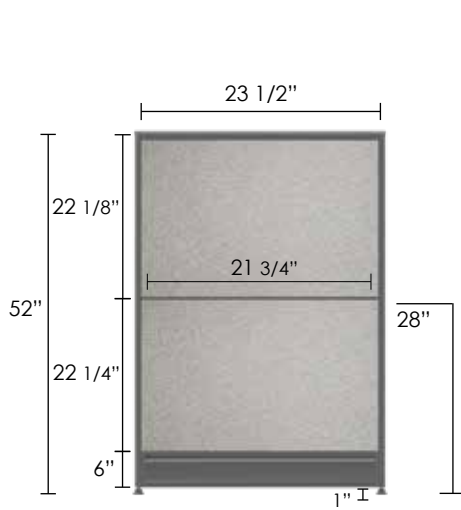



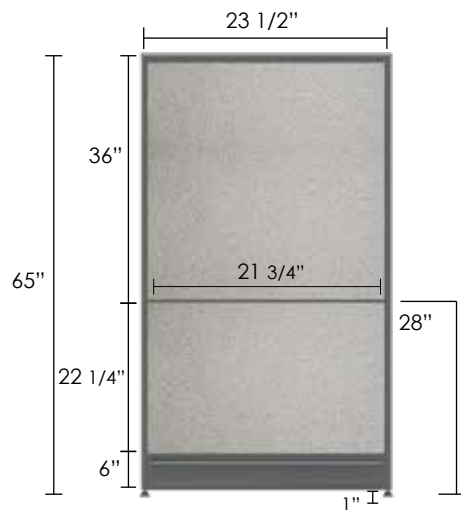



65" H Solid Panels



39"H-65"H Panels

Listed below is the panel information for 39-65"H panels. Panels are priced with tiles included.

	Description	SKU	Dimensions	Weight
	E39S	EP-2439S	24"W x 39"H	20 lb
		EP-3639S	36"W x 39"H	29 lb
	E52S	EP-2452S	24"W x 52"H	26 lb
		EP-3652S	36"W x 52"H	37 lb
	E52G	EP-2452G	24"W x 52"H	31 lb
		EP-3652G	36"W x 52"H	44 lb
	E65S	EP-2465S	24"W x 65"H	31 lb
		EP-3665S	36"W x 65"H	42 lb
	E65G	EP-2465G	24"W x 65"H	34 lb
		EP-3665G	36"W x 65"H	50 lb
	E65DG	EP-2465DG	24"W x 65"H	54 lb
		EP-3665DG	36"W x 65"H	70 lb

Decorative Film For Glass Panels

Choose a decorative film for any glass toppers in the Emerald Cubicle Collection to enhance the overall look even further.

Option 1: Single Side Glass Tile

Option 2: Double Side Glass Tile

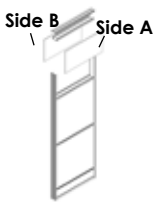

Description	SKU	Dimensions
One sided film	SS-FILM-25	up to 25"H
Two sided film	DS-FILM-25	up to 25"H

*Film can be placed on one or both sides of glass

Film Styles

*Films provided by Decorative Films



Frosted Leaf



Ice Forest Static Cling



Clear Waters Horizontal



Filigree Static Cling



Asher



Crystal Lattice



Frosted Vine Static Cling



Sand Static Cling



Stones Static Cling



Frosted Fall Static Cling







Flicker



Mystic

Accessories

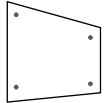
Add any of these accessories to your space to make the work day more convenient

Description	SKU	Dimensions	Weight
 Pencil Holder	EPH	3.7"H x 3.5"D x 3.7"W	1 lb
 Paper Rack	EFT	12"H x 10"D x 4"W	1 lb
 Paper Tray	EPT	12"H x 10"D x 4"W	
 Laminate Markerboard Material (Wilsonart)	EM2452S EM3652S EM2465S-MB EM-2465G-MD EM-3665S-MB EM-3665G-MB	21 1/2"W x 22"H 33 1/2"W x 22"H 21 1/2"W x 33 3/4"H 21 1/2"W x 22"H 33 1/2"W x 33 3/4"H 33 1/2"W x 22"H	
 Task Lights	235799-1-BS 235799-2-BS	24"W 36"W	10 lb 10 lb

*Markerboard pricing is for single sided. If placing on both sides of the panel the cost will be doubled.





Worksurfaces

Worksurfaces can be customized with any of our laminate finishes.

	Description	SKU	Dimensions	Weight
	Straight Worksurfaces	2424-NWS-CCODE	24"W x 24"D	13 lb
		3624-NWS-CCODE	36"W x 24"D	20 lb
		4824-NWS-CCODE	48"W x 24"D	27 lb
		6024-NWS-CCODE	60"W x 24"D	32 lb
		7024-NWS-CCODE	70"W x 24"D	39 lb
		7224-NWS-CCODE	72"W x 36"D	57 lb
	Corner Worksurface	CORNER-WWS-CCODE	35 5/8"W x 23 5/8"D x 23 5/8"W	28 lb
	Custom	3048-CUS-CCODE	30"W x 48"D	49 lb
		3060-CUS-CCODE	30"W x 60"D	49 lb
		3072-CUS-CCODE	30"W x 72"D	49 lb
		4896-CUS-CCODE	48"W x 96"D	100 lb
	120 Degree Worksurface	2436-V-CCODE	35 5/8"W x 35 5/8"W x 23 5/8"D	32 lb
		2448-V-CCODE	47 5/8"W x 47 5/8"W x 23 5/8"D	45 lb

When ordering, please specify desired color code at the end of the sku.

Laminate Color	CCODE
GRAY/WHITE	GW
SEA SALT/BLACK OAK	SSBO
DRIFTWOOD/MAPLE	DM









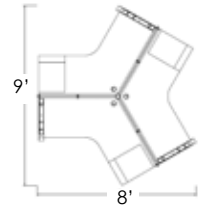

See pg. 13 to view laminate finishes.

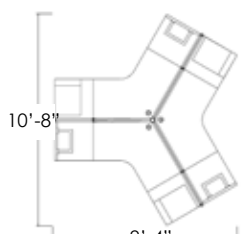
Worksurface Support

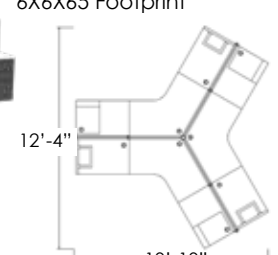
Parts needed to support the worksurfaces

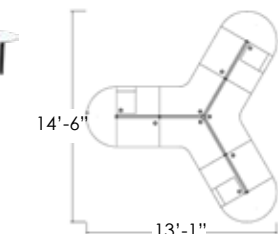
	Description	SKU	Dimensions	Weight
	Corner Worksurface Support	E-CC	3 1/4" D x 3" H (toothed side 1" W)	1 lb
	Right Cantilver	E-RT	2" W x 18" D x 8" H	3 lb
	Left Cantilver	E-LC	2" W x 18" D x 8" H	3 lb
	Double Cantilver	E-DC	3 1/4" W x 18" D x 8" H	3 lb
	Flat Bracket	FB	2" W x 6" D	1 lb
	Transaction Support/ Counter Top Bracket (Set of 4)	E-TB	2 3/4" H x 2 5/8" D Top: 2" W x 1 1/8" D Toothed Side: 2 1/2" H x 1 1/8" D	1 lb
	Wing Panel Stabilizer Bracket	E-WPS	3 3/4"W x 2"D	1 lb

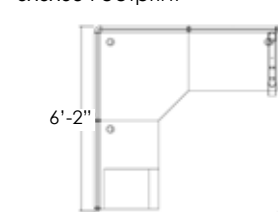
Footprints

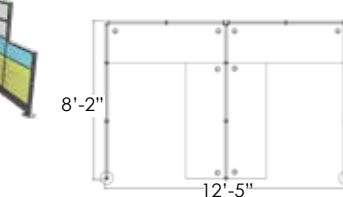
	Description	SKU	Dimensions	Weight
 	4x4x52 Footprint	EMTYP-120-4x4x52-G-1019	4'W x 4'D x 52"H	573 lb
 	5x5x65 Footprint	EMTYP-120-5x5x65-G-1019	5'W x 5'D x 65"H	751 lb
 	6x6x65 Footprint	EMTYP-120-6x6x65-52-G-1019	6'W x 6'D x 65"H	742 lb
 	6x6x65 Footprint	EMTYP-120-6x6x65-S-1019	6'W x 6'D x 65"H	892 lb
 	6x6x65 Footprint	EMTYP-LC06-6x6x65-G-1019	6'W x 6'D x 65"H	360 lb
 	6x6x65 Footprint	EMTYP-LC-6x8x65-39-SG-1019-01	6'W x 8'D x 65"H	1022 lb

Additional layout options for the Emerald Cubicle Collection

Customer Service

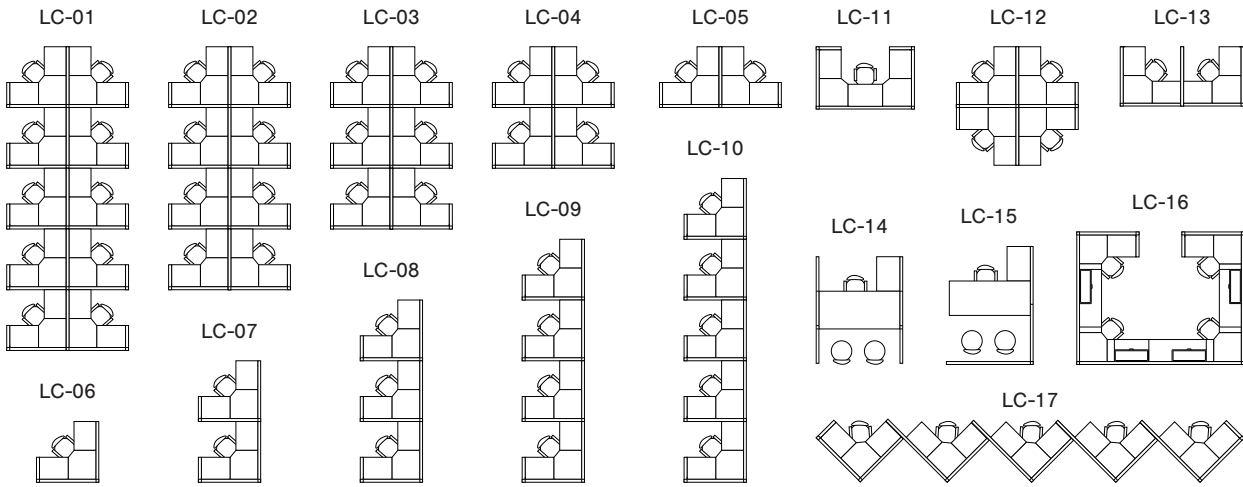

Executive

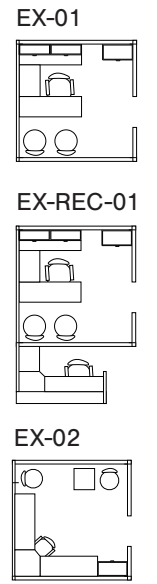

Call Center

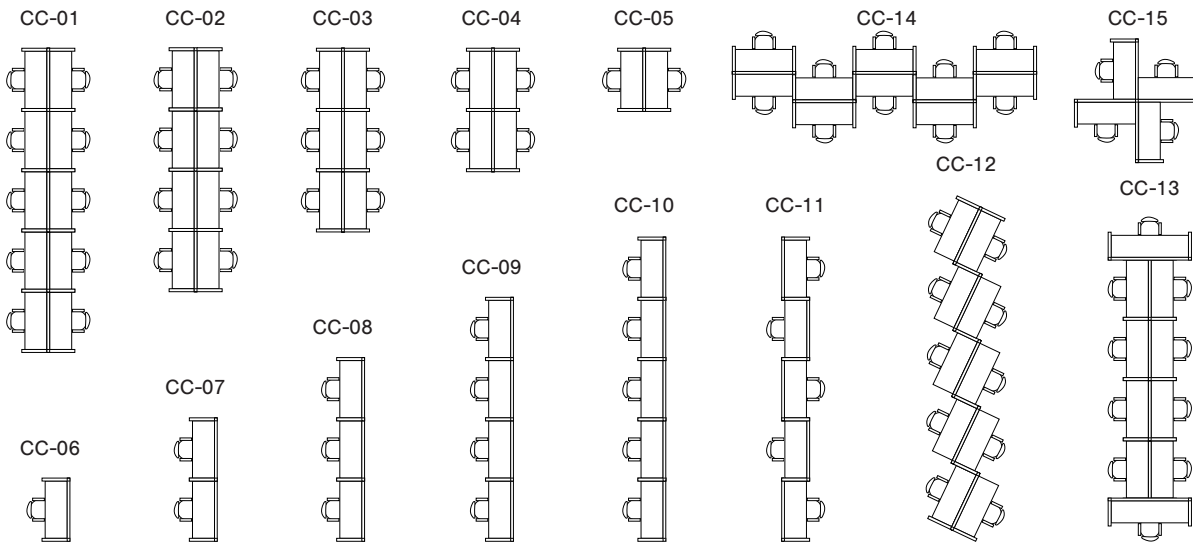

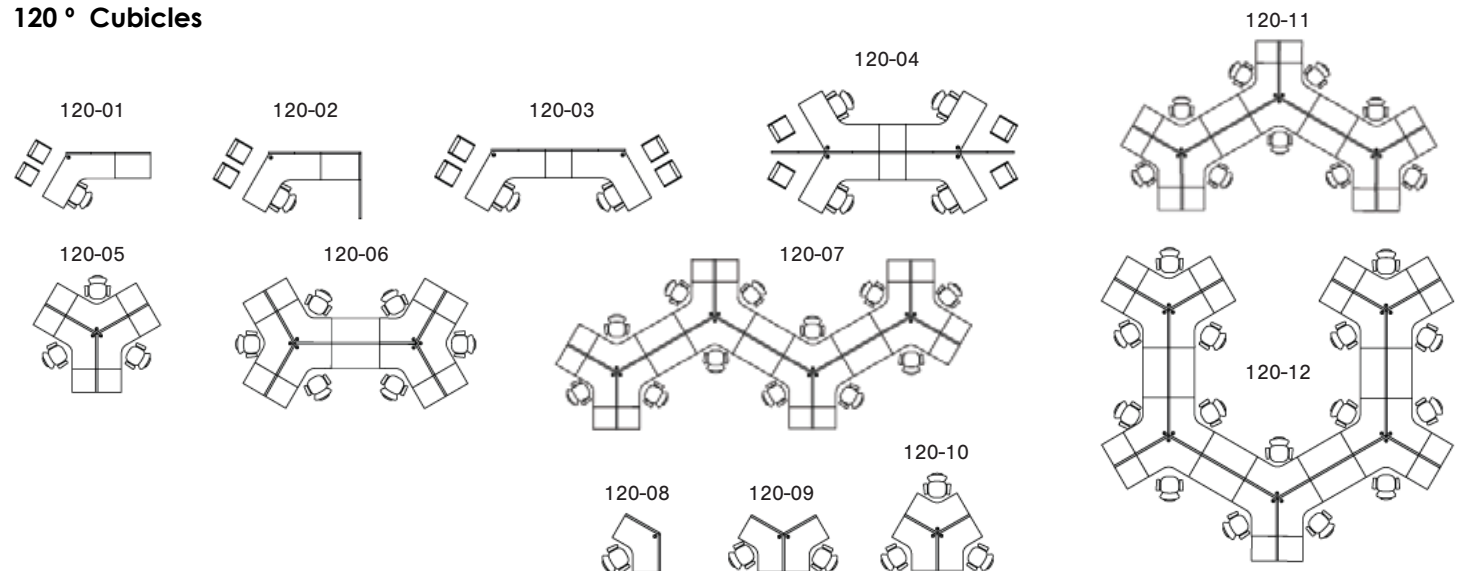

120° Cubicles









Support

Support options for system and worksurfaces

	Description	SKU	Dimensions	Weight
	Panel Support without Casters	PSL	1 3/4" W x 16 1/2" D x 7 1/2" H	3 lb
	Panel Support with Casters	PSL-CAST	1 3/4" W x 16 1/2" D x 8 1/2" H	4 lb
	Round Leg	RBL	8" Diameter x 6" H	1 lb
	Metal C-Leg with Wire Management	C-LEG	25 1/4" W x 2 3/4" D x 28" H	11 lb
	Box Leg	BOX-LEG	23 1/2" W x 1 1/2" D x 28" H	13 lb
	Standing Height Box Leg	BOX-LEG-SH	23 1/2" W x 40 1/4" H	12 lb

Storage



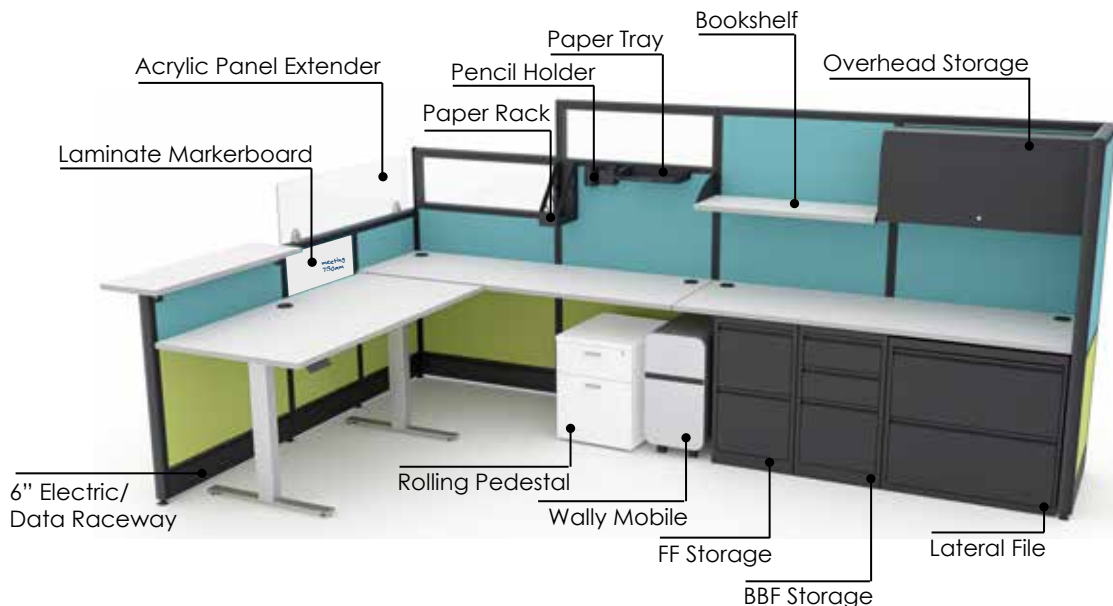

Keep your space organized with the help of these storage options.

	Description	SKU	Dimensions	Weight
	Box/Box/File Pedestal	BBF-F-CHAR	15 7/8"W x 19 11/16"D x 29" 1/2"H	54 lb
	File/File Pedestal	FF-F-CHAR	15 7/8"W x 22"D x 27 1/2"H	54 lb
	30" 2 Drawer Lateral File Pedestal	LAT-F-CHAR	30" 2 Drawer Lateral File Pedestal	75 lb
	Box/File Rolling Pedestal with Cushions	DIA-LMP-CUSH	20"D x 15"W x 23 1/2"H	28 lb
	Wally Mobile Storage	UN-WALLY	19 1/2"L x 12 3/16"W x 20 1/8"H	--
	Bookshelf Available in 26"W & 36"W	1324-BS 1336-BS	24"W x 12.5"D 36"W x 12.5"D	7 lb 11 lb
	Locking Overhead Available in 24"W & 36"W	EOC-24 EOC-36	24"W x 12"D x 12"H 36"W x 12"D x 12"H	38 lb 47 lb





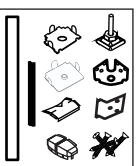
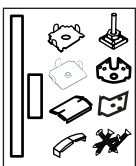

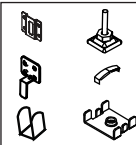
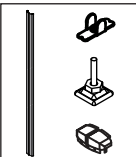

Connectors

Connectors for the Emerald Cubicle Collection

	Description	SKU	Dimensions	Weight
	2-Way 120° Connector	E39-120-2WAY E52-120-2WAY E65-120-2WAY		1 lb 1 lb 1 lb
	3-Way 120° Connector	E39-120-3WAY E52-120-3WAY E65-120-3WAY		1 lb 1 lb 2 lb
	2-Way L-Step Down Connector	L-SD-65-52 L-SD-65-39 L-SD-52-39		1 lb 1 lb 1 lb
	3-Way Step Down T Connector Exterior	T1-SD-65-52-65 T1-SD-65-39-65 T1-SD-52-39-52 T2-SD-65-52-52 T2-SD-65-39-39 T2-SD-52-39-39		1 lb 1 lb 1 lb 1 lb 1 lb 1 lb
	3-Way Step Down T Connector Interior	T3-SD-52-65-65 T3-SD-39-65-65 T3-SD-39-52-52 T4-SD-52-65-52 T4-SD-39-65-39 T4-SD-39-52-39		1 lb 1 lb 1 lb 1 lb 1 lb 1 lb
	4-Way X-Step Down Connector	X1-SD-65-65-52-65 X1-SD-65-65-39-65 X1-SD-52-52-39-52 X2-SD-65-52-52-52 X2-SD-65-39-39-39 X2-SD-52-39-39-39 X3-SD-65-52-65-52 X3-SD-65-39-65-39 X3-SD-52-39-52-39		1 lb 1 lb 1 lb 1 lb 1 lb 1 lb 1 lb 1 lb 1 lb
	Straight Connector	PP-SD-65-52 PP-SD-65-39 PP-SD-52-39		1 lb 1 lb 1 lb
	End Trim	E39-ET E52-ET E65-ET		1 lb 1 lb 1 lb

Electric/Data

Electric and Data can be added to the baseline of each panel using the 6" electric and data raceways.

	Description	SKU	Dimensions	Weight
	31" Flex Cable	31-8W-4C	31"	2 lb
	58" Flex Cable	54-8W-4C	54"	2 lb
	68" Flex Cable	68-8W-4C	68"	3 lb
	NYC Base Power Feed with Junction Box and 60" Whip	8W-4C-BASE	60"	4 lb
	8 Wire, 4 Circuit Double Sided Power Module	8W-4C-DS	—	1 lb
	Black Blank Outlet	BLANK-REC-8W-4C	—	1 lb
	8W-4C 1 Receptacle Circuit	1-REC-8W-4C	—	1 lb
	8W-4C 2 Receptacle Circuit	2-REC-8W-4C	—	1 lb
	8W-4C 4 Receptacle Circuit	4-REC-8W-4C	—	1 lb
	8W-4W Dedicated Orange Circuit	3-REC-8W-4C-ISOLATED	—	1 lb
	Wire Snake	WM-SN	—	1 lb
	Phone Jack	AT34-15	—	1 lb
	CAT 6 Jack	AT66-20	—	1 lb
	Data Blank	AT31-00	—	1 lb
	Filler Cap For Data Plates	FILL-CAP	—	1 lb
	Data Plate	AT4FM	—	1 lb

Emerald Cubicle Collection Electric Raceway - Open with electric

Emerald Cubicle Collection Electric Raceway - Open without electric



⚠ FINAL CONNECTION IS DONE BY A LICENSED ELECTRICIAN

WARNING: Risk of fire or electric shock. As with all non-directional systems, do not electrically connect panel to more than one supply source. Always determine that the panel is electrically connected to one and only one source of supply. Before using any equipment, check the entire system for polarity, continuity, and grounding integrity.

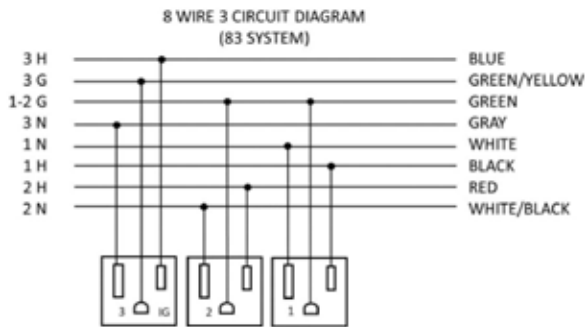
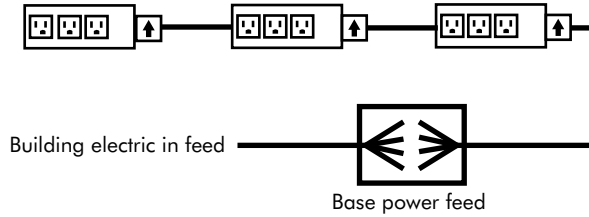
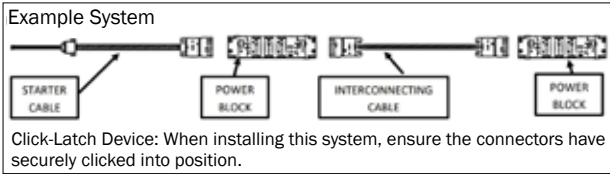
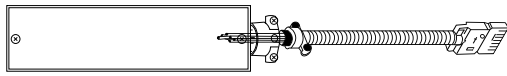

Power Supply Connection

The Power System is an eight wire system consisting of four individual circuits rated at 20 amps/120 volts maximum. Circuit 1 (black), circuit 2 (red), and circuit 4 (pink), are served by a system neutral (white) and an equipment ground (green). Circuit 3 (blue) uses an isolated neutral (gray), and an isolated ground (green/yellow). The system may be supplied by a three phase power system with four individual circuits rated 20 amps/120 volts maximum, or as permitted by local code.

When connecting electric pass throughs to power moduals, please make sure ARROW is up

Outlet Layout Options



OUTLET - BLANK - BLANK



OUTLET - OUTLET - BLANK



OUTLET - OUTLET - OUTLET



OUTLET - DEDICATED* - BLANK

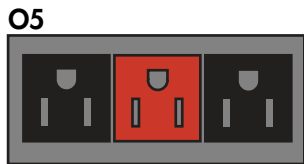

OUTLET - DEDICATED* - OUTLET

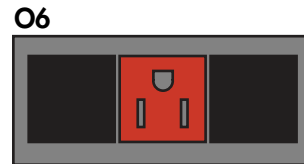

BLANK - DEDICATED* - BLANK

***PLEASE NOTE:** Orange is used to represent the dedicated outlet. The actual color of the outlet is **black**.

EMERALD Cubicles come with style #225 Outlets.
SAPPHIRE Cubicles come with style #325 Outlets.



CAT 6 - Blank - Blank - Blank

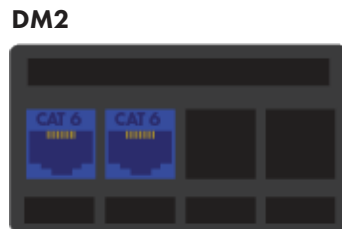

CAT 6 - CAT 6 - Blank - Blank



CAT 6 - CAT 6 - CAT 6 - Blank

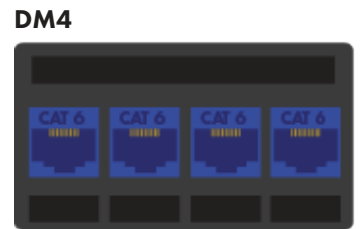

CAT 6 - CAT 6 - CAT 6 - CAT 6



CAT 6 - Phone Jack - Blank - Blank

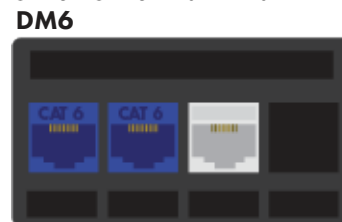

CAT 6 - CAT 6 - Phone Jack - Blank

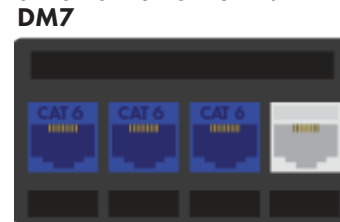

CAT 6 - CAT 6 - CAT 6 - Phone Jack

All Modules can be customized to customers specifications. Please call to review options with one of our sales representatives. Color of jacks may vary.

Fabric

Our 14 in house fabric options to customize panels of the Emerald Cubicle Collection

***Please note:** The finish samples below are digital representations. Colors may vary. Please refer to an actual sample before finalizing your selections.



Silver
(15-108)



Toffee
(15-09)



Lime-Green
(15-118)



Slate
(15-41)



Gold
(15-155)



Royal Blue
(15-167)



Scarlet
(15-164)



Pumpkin
(15-75F)



Charcoal
(15-13)



Cool Aqua
(15-175)



Sage
(15-103)



Midnight
(15-03)



Blue Lagoon
(15-107)



Banana
(15-104)

Laminate For Worksurfaces

Laminate options for the worksurfaces.

***Please note:** The finish samples below are digital representations. Colors may vary. Please refer to an actual sample before finalizing your selections.



Applewood
(XD-07)



Black Oak
(XD-1025)



Driftwood
(XD-21)



Light Gray
(XD-01)



Mocha Walnut
(XD-13)



Sea Salt
(XD-1026)



Maple
(XD-08)

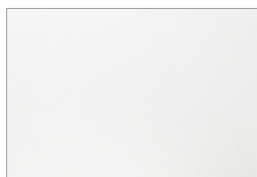

White
(XD-09)



Walnut
(XD-14)



Gray Speckle
(XD-17)

Fabric Testing

Test results of how our fabric quality holds up under certain conditions.

Test item	Test Standard	Unit		Test Result	
				Small	Pear
Color Fastness to Water	AATCC107-2002	Srain	Fading	4	4
	GB/T5713-1997	Srain	Fading	4	4
Color Fastness to Perspiration	AATCC15-2002	Srain	Fading	4	4
	GB/T3922-1997	Srain	Fading	4-5	4-5
Color Fastness to Washing	ISO 105-C03:1989	Srain	Fading	4-5	4-5
	GB/T3921.3-1997	Srain	Fading	4-5	4-5
Color Fastness to Light	ISO 105-B02:1997	Xenon-Lamp		5	
	GB/T8427-1998	Xenon-Lamp		5	
Color Fastness to Rubbing	AATCC8:2001	Dry	Wet	4-5	4-5
	GB/T 3920-1997	Dry	Wet	4-5	4-5
Tear Strength	ASTM D2261	Wrap	Filling	12.5	10.3
	GB/T3917.2-1997	Wrap	Filling	11	8.5
Seam Slippage Strength	ASTM D434	Wrap	Filling	17.5	22
	GB/T 13772.1-1992	Wrap	Filling	16	19.5
Seam Breaking Strength	ASTM D1683-04	Wrap	Filling	31.5	26.5
	GB/T 13773-1992	Wrap	Filling	45.9	47.7
Tensile Strength	ASTM D5034-1995-1	Wrap	Filling	87	63
	GB/T3923.2-1997	Wrap	Filling	88	65
Burst Strength	ASTM D3787	cm ²		117.9	
Abrasion Resistance	ASTM D4966-98 Martindale 12Kpa			over 30,000	
Flammability Test Required	California Technical Bulletin 117 Section E, Part I (CS191-53)			Pass	
	BS 5852 Part I: 1979, Match Test			Pass	

